

optional Eindrehschlauder Art. 2.2
ohne Befestigungsmittel

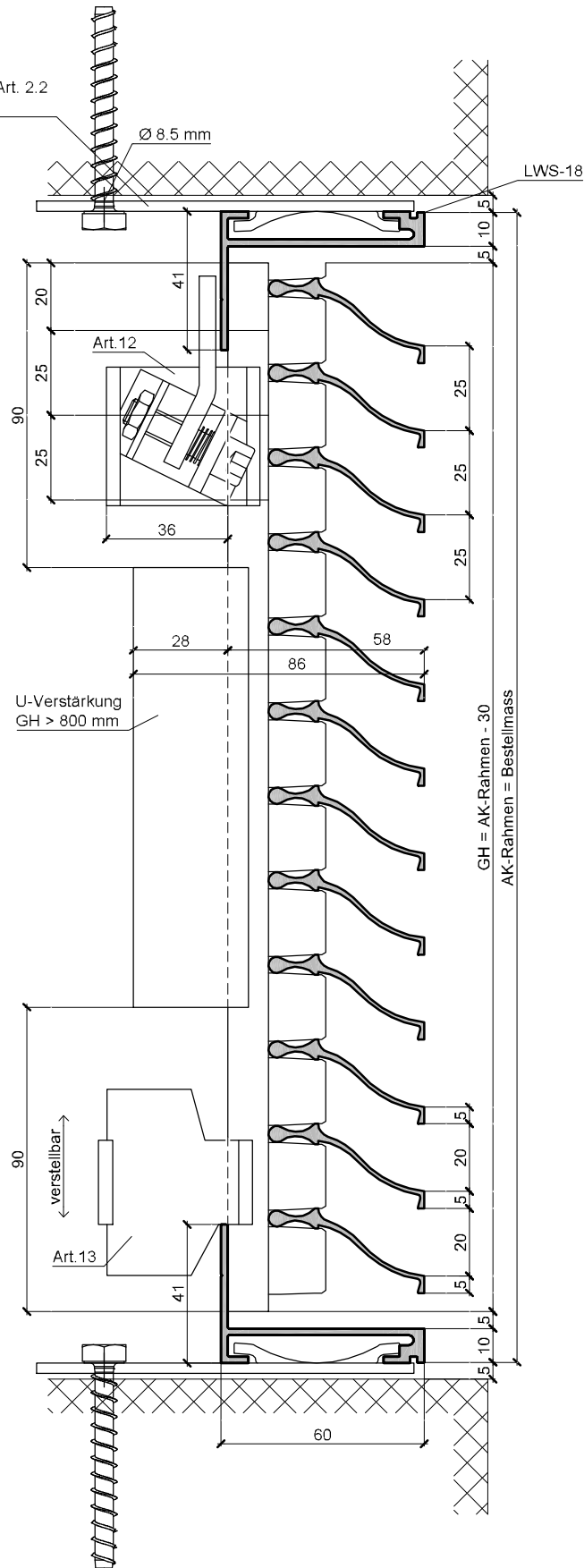

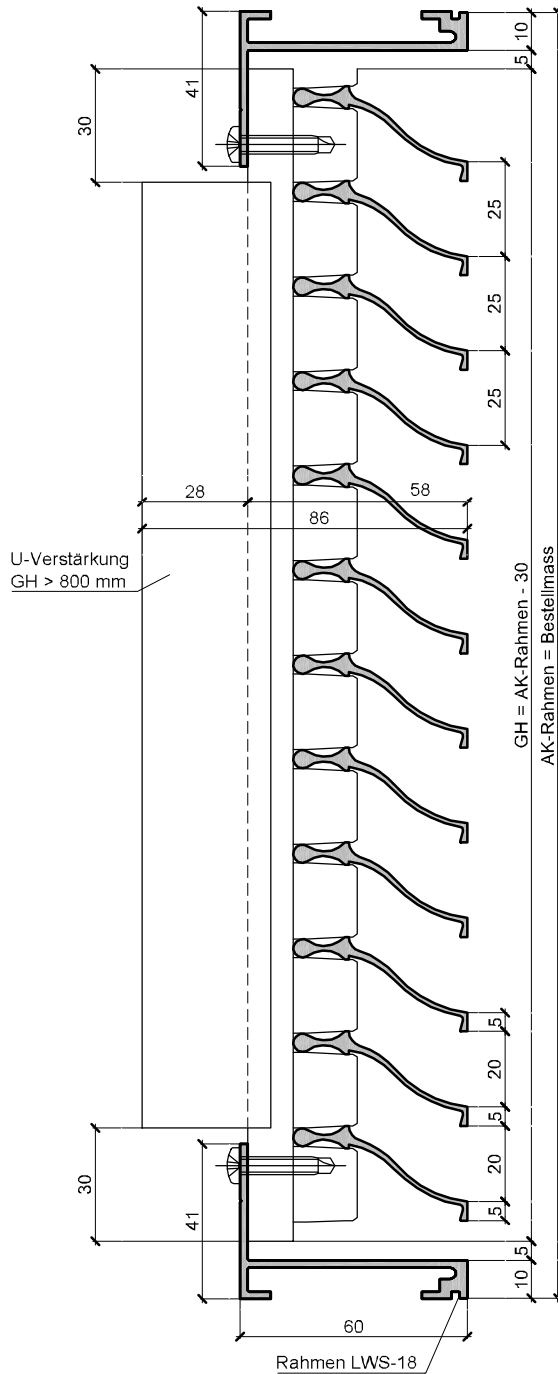

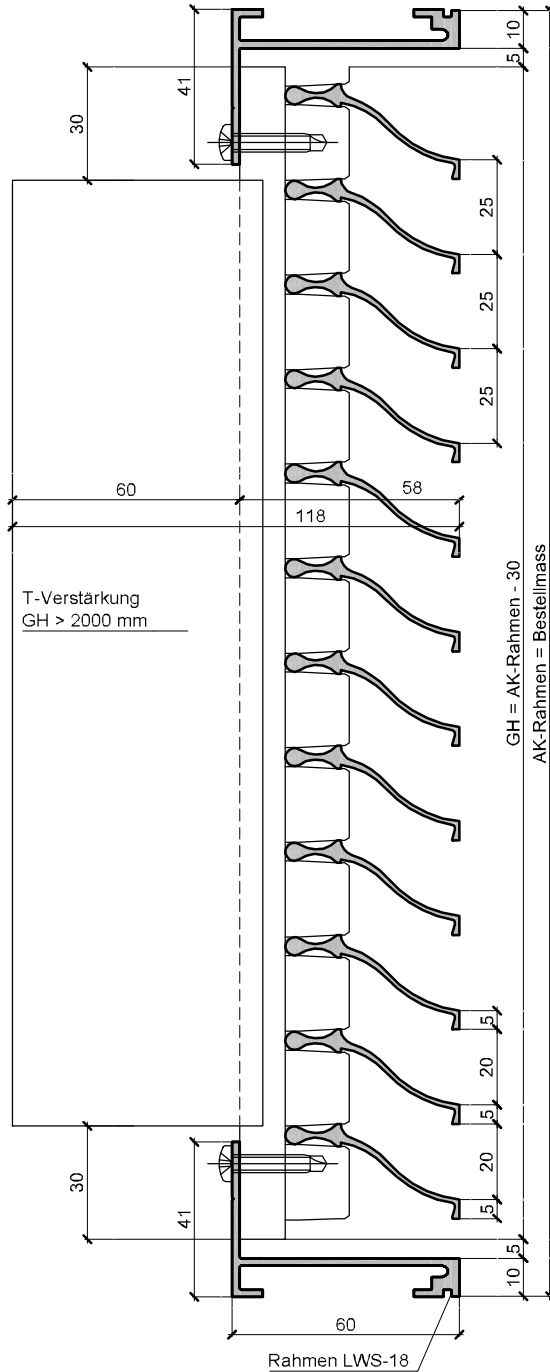

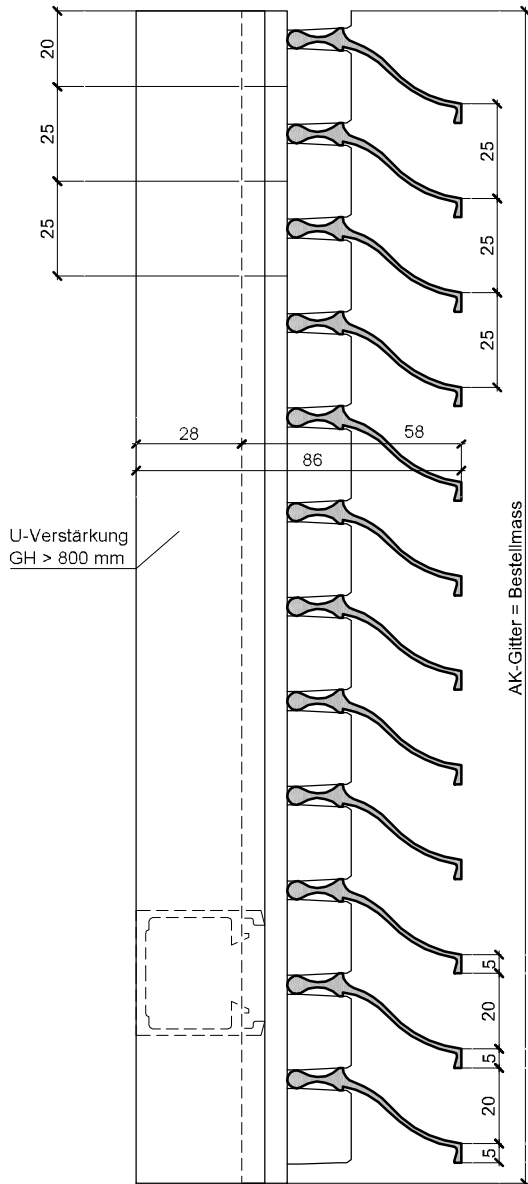

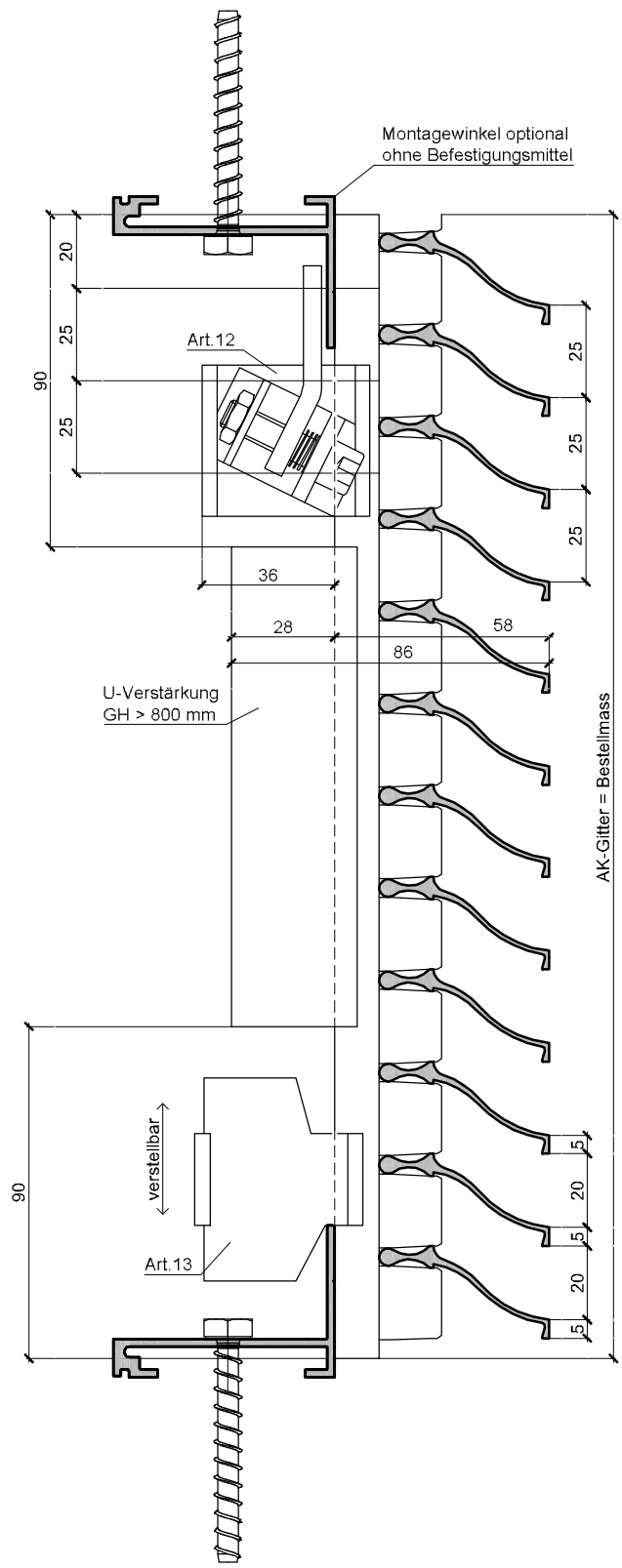

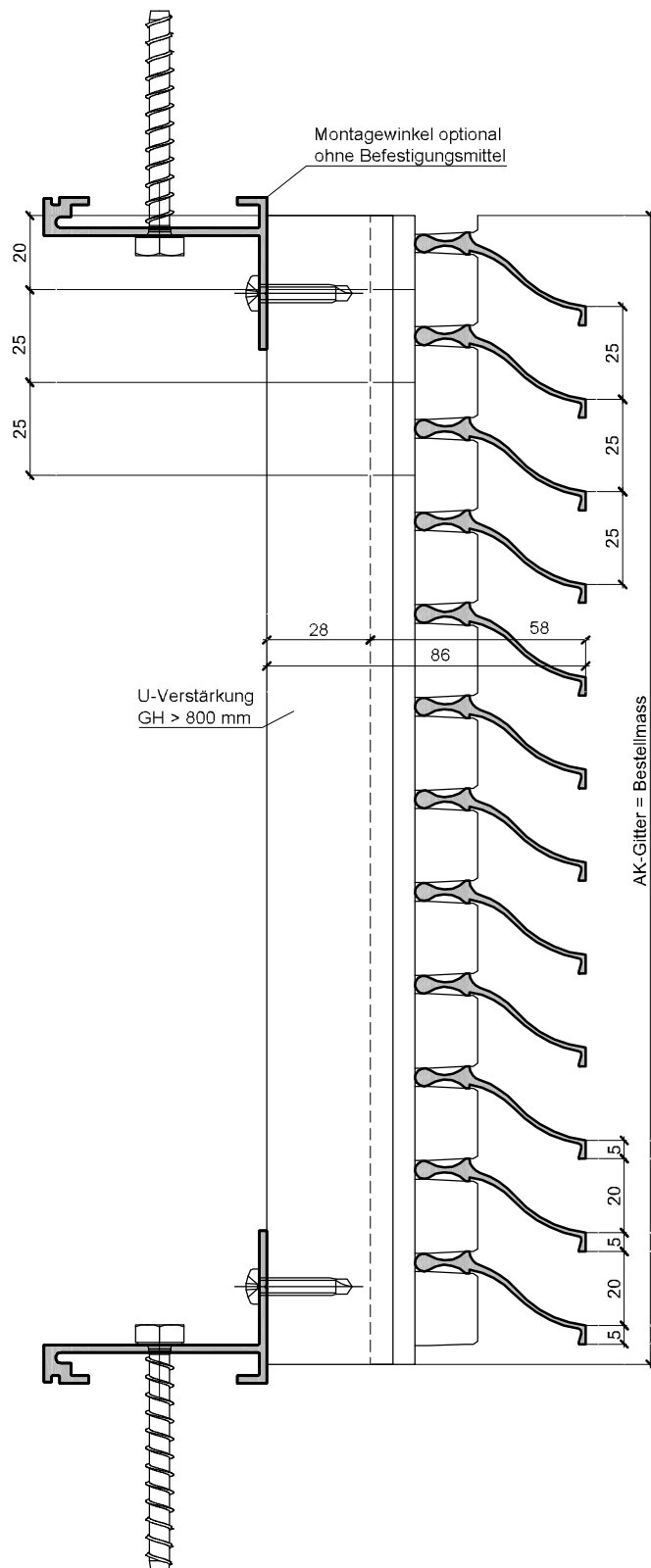

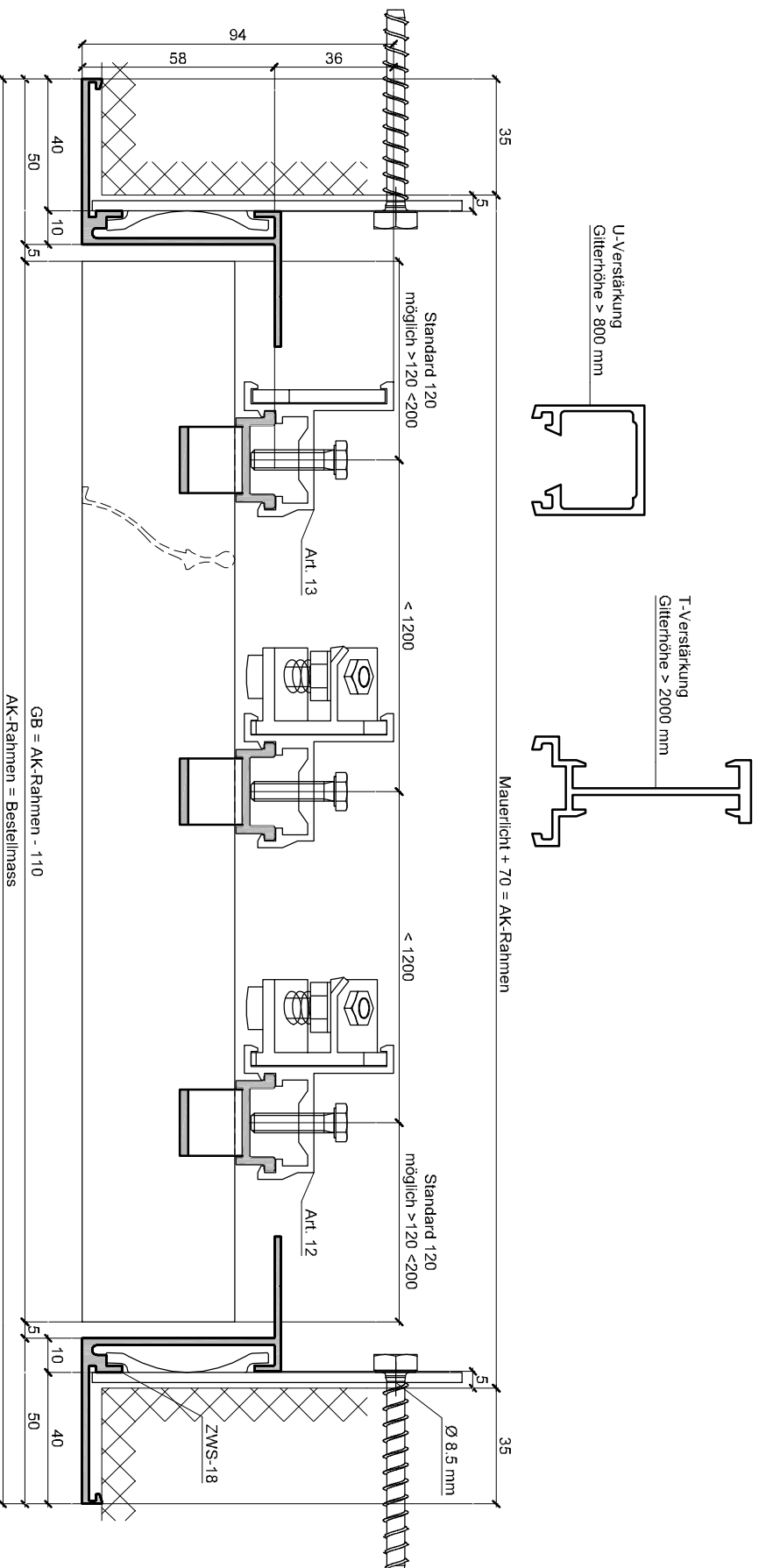

Aluhit Gitter WS-18, Rahmen ZWS-18, mit Art. 12 u. 13 zum Befestigen von aussen

Wyss Aluhit AG, Grossmatte 9, CH-6014 Luzern, Tel. +41 41 259 11 00, info@wyssaluhit.ch

WS-18

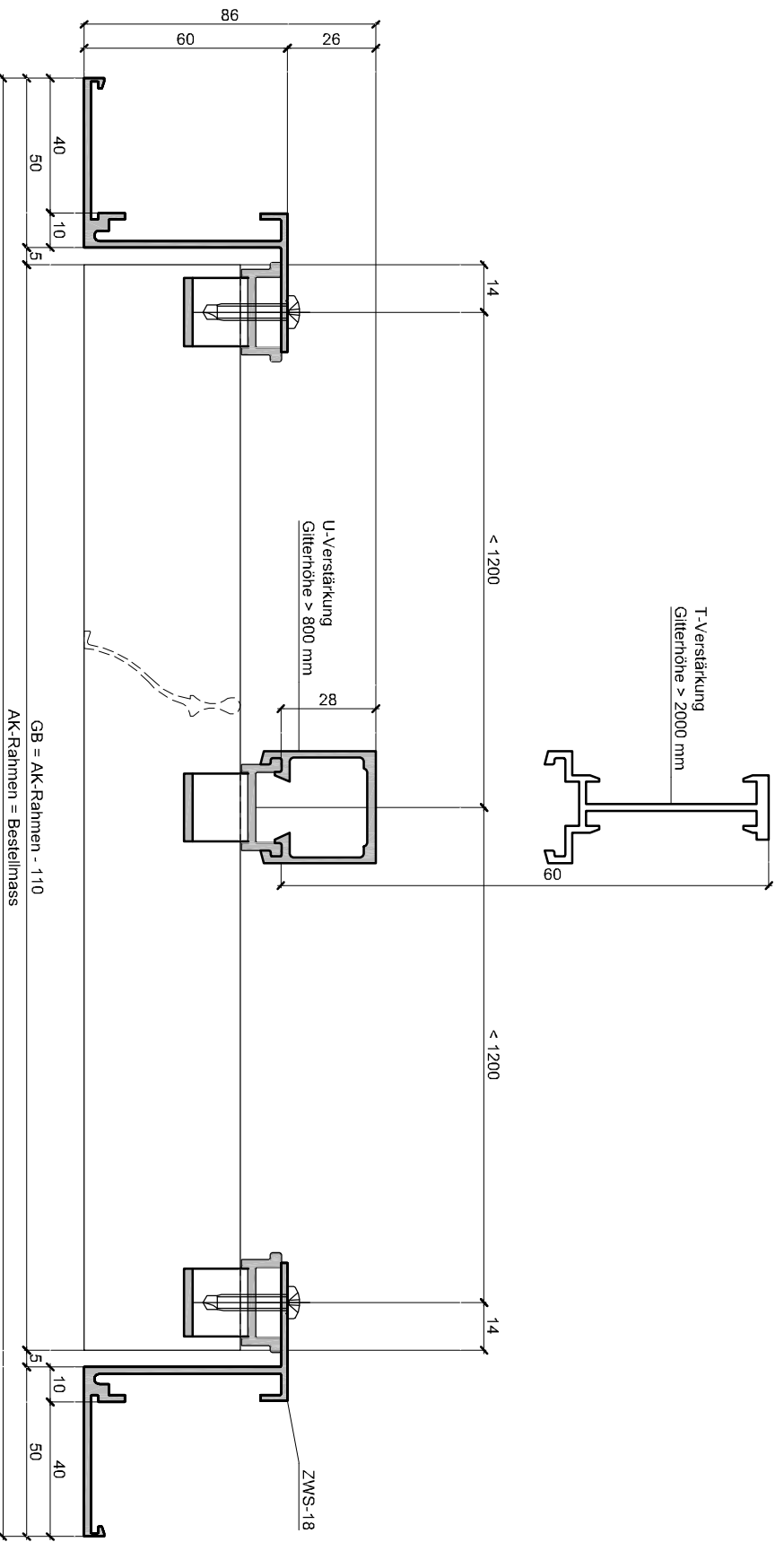

Aluhit Gitter WS-18, Rahmen ZWS-18, mit Rahmen verschraubt

Wyss Aluhit AG, Grossmatte 9, CH-6014 Luzern, Tel. +41 41 259 11 00, info@wyssaluhit.ch

WS-18 / ZWS-18

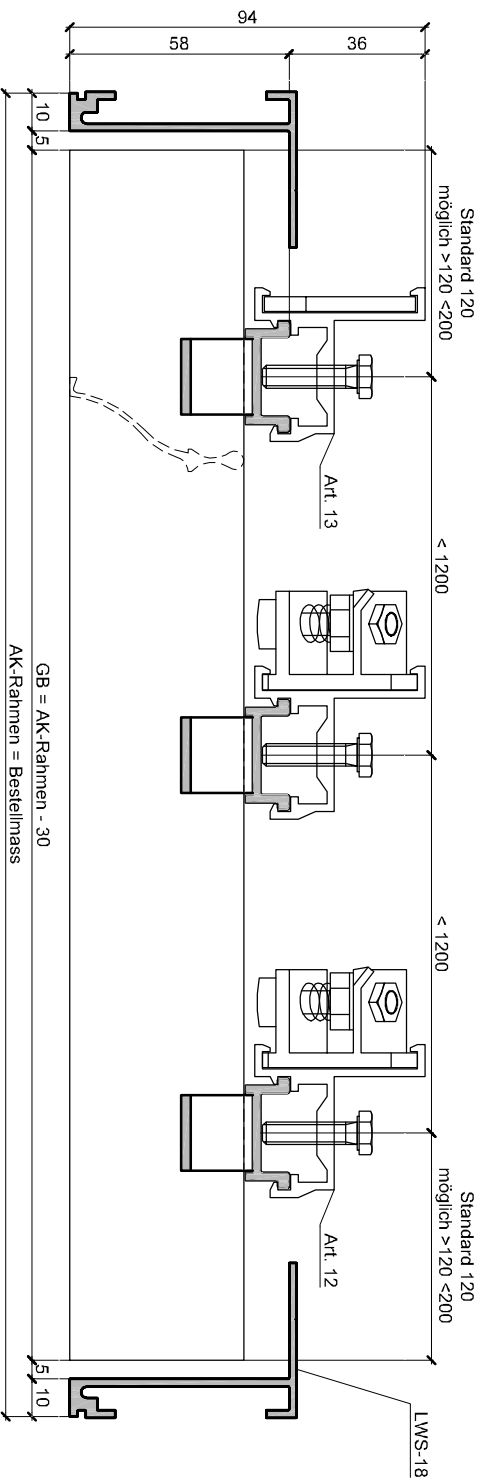
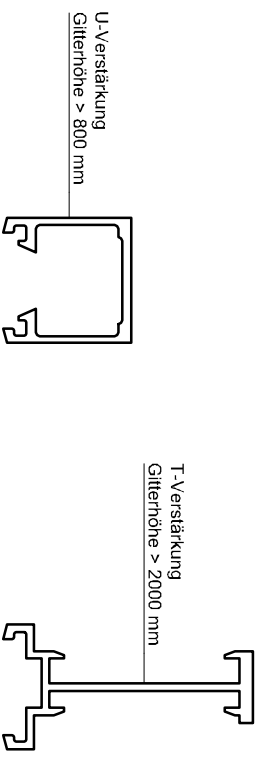

Aluhit Gitter WS-18, Rahmen LWS-18, mit Art. 12 u. 13 zum Befestigen von aussen

Wyss Aluhit AG, Grossmatte 9, CH-6014 Luzern, Tel. +41 41 259 11 00, info@wyssaluhit.ch

WS-18 / ZWS-18

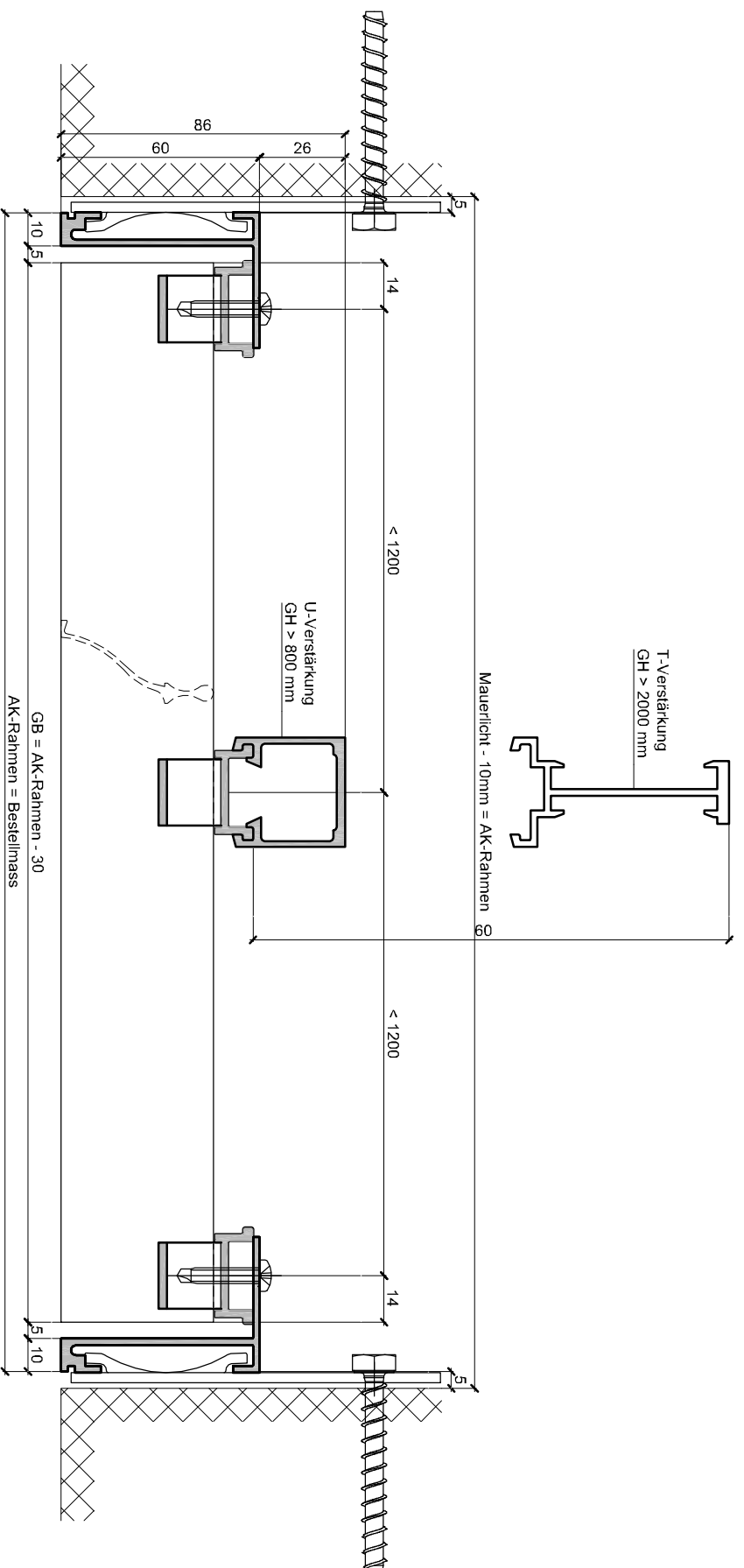

Aluhit Gitter WS-18, Rahmen LWS-18, mit Rahmen verschraubt

Wyss Aluhit AG, Grossmatte 9, CH-6014 Luzern, Tel. +41 41 259 11 00, info@wyssaluhit.ch

WS-18

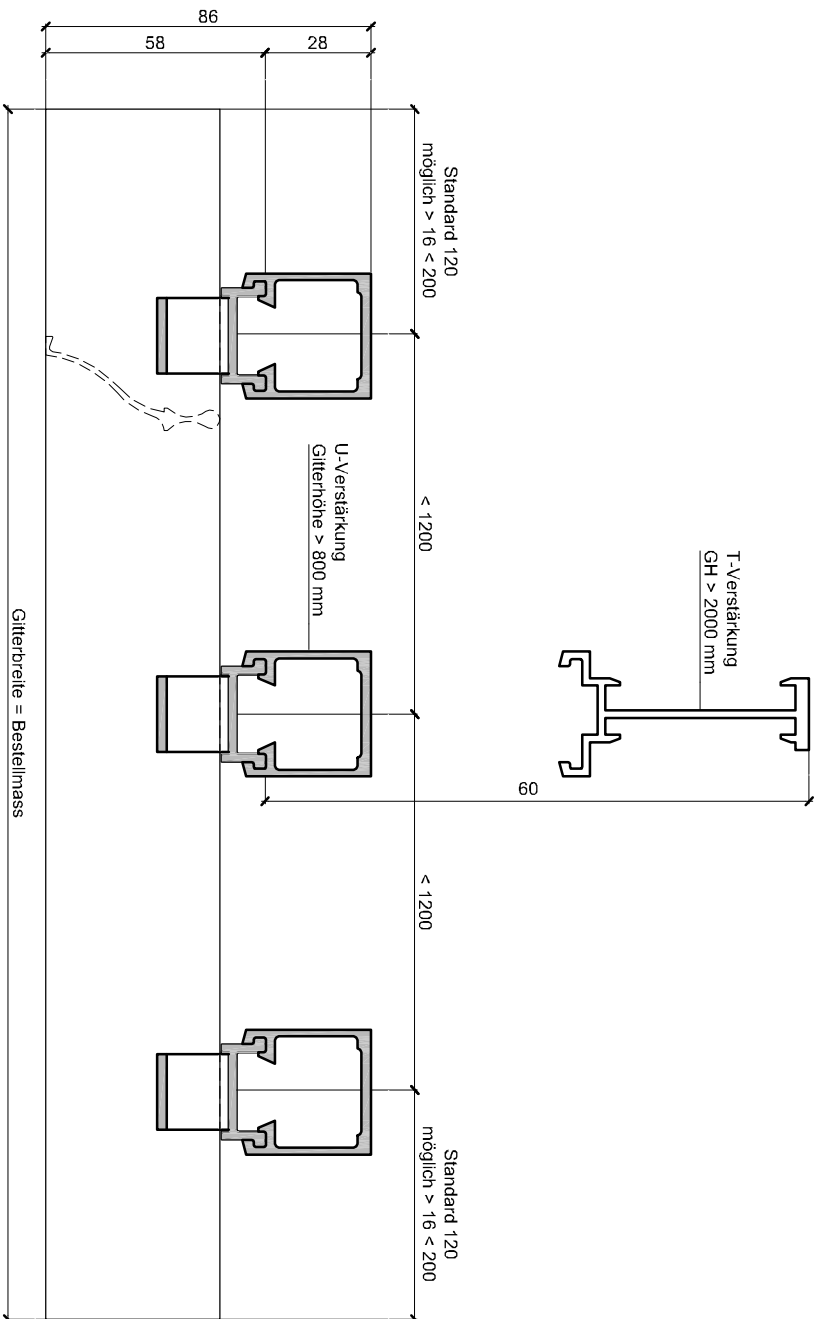

Aluhit Gitter WS-18, ohne Rahmen

Wyss Aluhit AG, Grossmatte 9, CH-6014 Luzern, Tel. +41 41 259 11 00, info@wyssaluhit.ch

WS-18

24

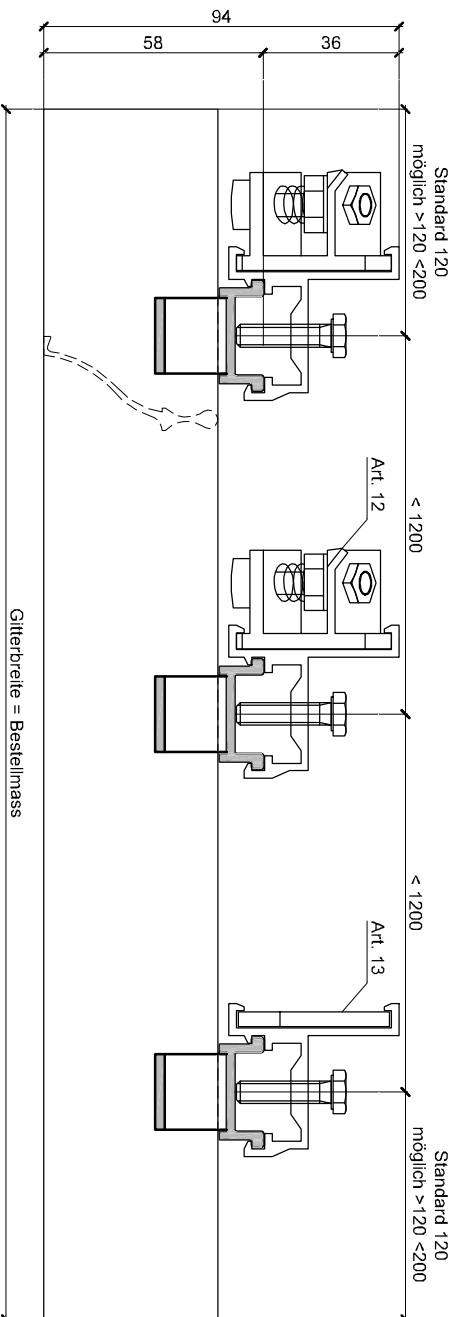
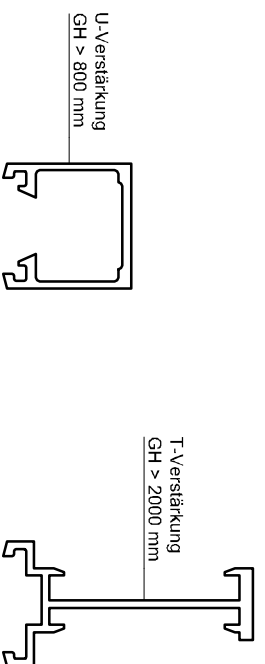

Aluhit Gitter WS-18, ohne Rahmen, mit Art. 12 u. 13 zum Befestigen von aussen

Wyss Aluhit AG, Grossmatte 9, CH-6014 Luzern, Tel. +41 41 259 11 00, info@wyssaluhit.ch

WS-18

25